

Schema di montaggio

Assembly scheme
Schéma de montage
Esquema de montaje

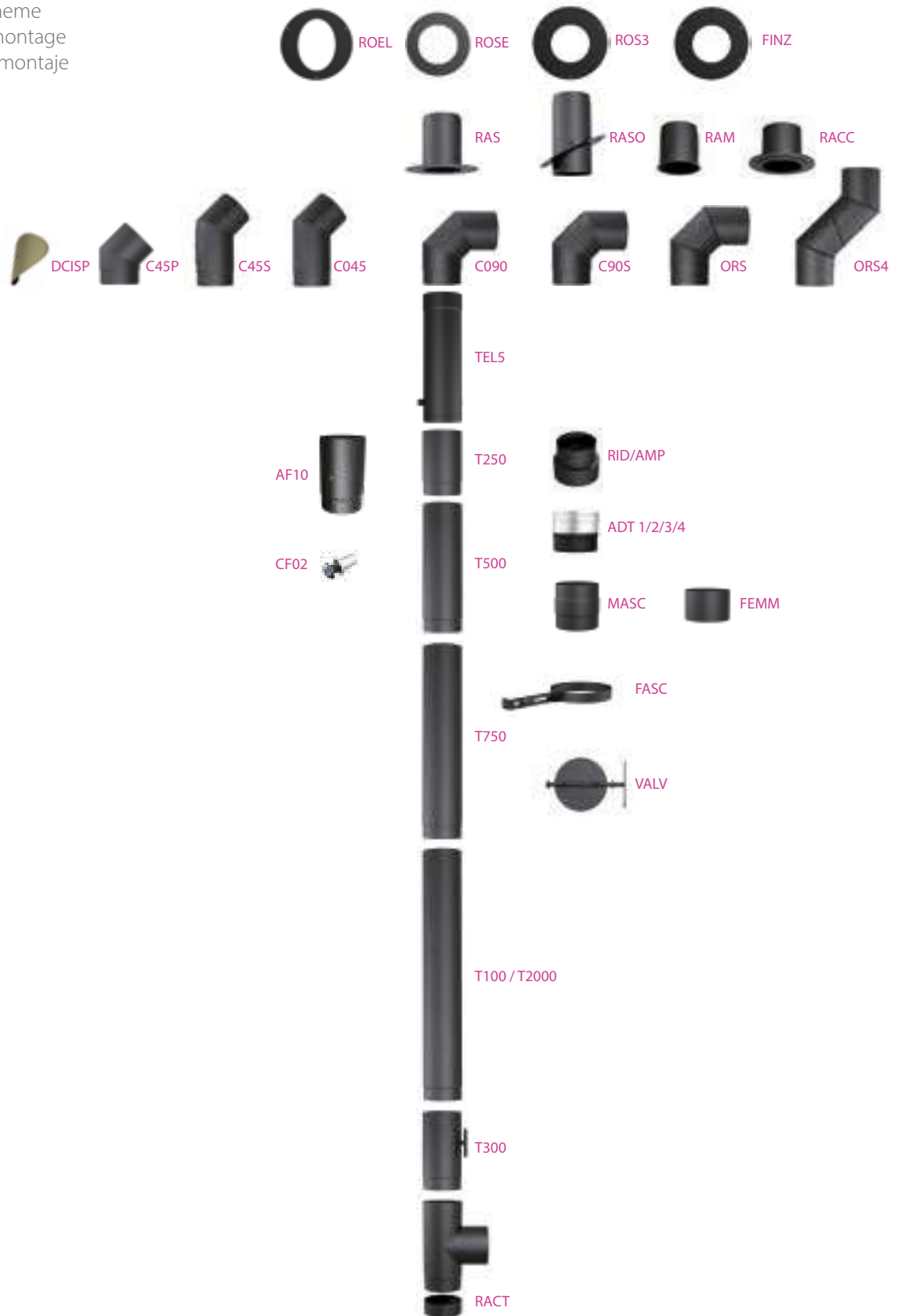

CF02 - TAPPO PER ANALISI FUMI M10 - Cap for smoke analysis M10 - Bouchon pour analyse des fumées M10 - Tapón para análisis de humos M10

ISTRUZIONI PER L'USO - Instructions for use - Instructions pour l'utilisation - Instrucciones de uso



- Con il trapano, praticare sul tubo a 90° un foro da 13 mm
- With a drill, make a 13mm hole on the pipe at 90°
- Avec une perceuse, faire sur le tuyau à 90° un trou de 13mm
- Con el taladro, haga un agujero de 13 mm en el tubo a 90°



- Assemblare l'inserto mediante apposita attrezzatura tirainseriti (M10)
- Assemble the insert through a proper riveter equipment (M10)
- Assembler l'insert à travers un équipement riveteuse approprié (M10)
- Ensamble el inserto utilizando el equipo extractor de insertos apropiado (M10)



- Applicare la vite di chiusura
- Apply the closing screw
- Appliquer la vis de fermeture
- Aplicar el tornillo de bloqueo



EN 1856-2:2009
No. 0476-CPR-2977

Linea LEGNA

Canali da fumo in acciaio alluminato

PLUS e CARATTERISTICHE TECNICHE:

- struttura robusta, spessore 2 mm
- verniciatura siliconica liquida antigraffio
- temperatura massima d'esercizio 400°C

Tuyaux de raccordement en acier aluminisé.

AVANTAGES ET CARACTÉRISTIQUES TECHNIQUES :

- structure robuste, épaisseur 2 mm
- peinture silicone liquide anti-rayures
- température de travail jusqu'à 400 ° C

Connecting flue pipes made of aluminized steel.

PLUS and TECHNICAL CHARACTERISTICS:

- robust structure, 2 mm thickness
- scratchproof liquid silicone paint
- working temperature up to 400°C

Conductos de humos de acero aluminizado.

VENTAJAS Y CARACTERÍSTICAS TÉCNICAS:

- estructura robusta, 2 mm de espesor
- revestimiento de silicona líquida a prueba de arañazos
- temperatura máxima de funcionamiento 400 °C

T400-N1-D-V2-L05180-G800

Ø disponibili
Ø available
Ø disponibles
Ø disponibles

da 120 a 250 mm

Finiture disponibili
Available finishes
Finitions disponibles
Acabados disponibles

F.01



NERO OPACO
MAT BLACK - NOIR MAT
NEGRO MATE

F.02



GRIGIO
GREY - GRIS - GRIS

T250

Elemento lineare

Linear element - Élément droit - Elemento lineal

Finiture disponibili - Available finishes - Finitions disponibles - Acabados disponibles

F. 01 NERO BLACK NOIR - NEGRO		F. 02 GRIGIO GREY GRIS - GRIS		Ø	L	📦
D120T250		G120T250		120	250	1
D130T250		G130T250		130	250	1
D140T250		G140T250		140	250	1
D150T250		G150T250		150	250	1
D160T250		G160T250		160	250	1
D180T250		G180T250		180	250	1
D200T250		G200T250		200	250	1
D250T250		G250T250		250	250	1

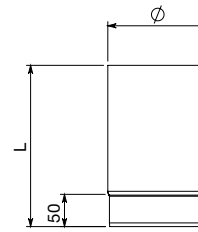

T300

Elemento lineare completo di valvola

Linear element with valve - Élément droit avec clé - Elemento lineal con válvula

Finiture disponibili - Available finishes - Finitions disponibles - Acabados disponibles

F. 01 NERO BLACK NOIR - NEGRO		F. 02 GRIGIO GREY GRIS - GRIS		Ø	L	📦
D120T300		G120T300		120	300	1
D130T300		G130T300		130	300	1
D140T300		G140T300		140	300	1
D150T300		G150T300		150	300	1
D160T300		G160T300		160	300	1
D180T300		G180T300		180	300	1
D200T300		G200T300		200	300	1

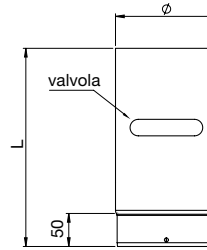

AF10

Elemento lineare completo di analisi fumi M10-gas

Linear element with smoke analysis M10-gas - Élément droit avec analyse des fumées M10-gaz

Elemento lineal completo con análisis de humos M10-gas

Finiture disponibili - Available finishes - Finitions disponibles - Acabados disponibles

F. 01 NERO BLACK NOIR - NEGRO		F. 02 GRIGIO GREY GRIS - GRIS		Ø	L	📦
D120AF10		G120AF10		120	250	1
D130AF10		G130AF10		130	250	1
D140AF10		G140AF10		140	250	1
D150AF10		G150AF10		150	250	1
D160AF10		G160AF10		160	250	1
D180AF10		G180AF10		180	250	1
D200AF10		G200AF10		200	250	1
D250AF10		G250AF10		250	250	1

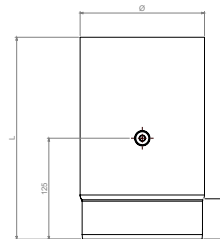

T500

Elemento lineare

Linear element - Élément droit - Elemento lineal

Finiture disponibili - Available finishes - Finitions disponibles - Acabados disponibles

F. 01 NERO BLACK NOIR - NEGRO		F. 02 GRIGIO GREY GRIS - GRIS		Ø	L	📦
D120T500		G120T500		120	500	1
D130T500		G130T500		130	500	1
D140T500		G140T500		140	500	1
D150T500		G150T500		150	500	1
D160T500		G160T500		160	500	1
D180T500		G180T500		180	500	1
D200T500		G200T500		200	500	1
D250T500		G250T500		250	500	1

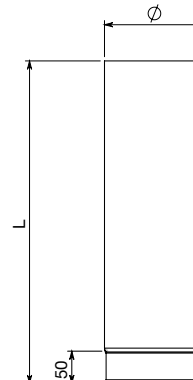

T750

Elemento lineare

Linear element - Élément droit - Elemento lineal

Finiture disponibili - Available finishes - Finitions disponibles - Acabados disponibles

F. 01 NERO BLACK NOIR - NEGRO		F. 02 GRIGIO GREY GRIS - GRIS		Ø	L	☐
D120T750		G120T750		120	750	1
D130T750		G130T750		130	750	1
D140T750		G140T750		140	750	1
D150T750		G150T750		150	750	1
D160T750		G160T750		160	750	1
D180T750		G180T750		180	750	1
D200T750		G200T750		200	750	1



T100

Elemento lineare

Linear element - Élément droit - Elemento lineal

Finiture disponibili - Available finishes - Finitions disponibles - Acabados disponibles

F. 01 NERO BLACK NOIR - NEGRO		F. 02 GRIGIO GREY GRIS - GRIS		Ø	L	☐
D120T100		G120T100		120	1000	1
D130T100		G130T100		130	1000	1
D140T100		G140T100		140	1000	1
D150T100		G150T100		150	1000	1
D160T100		G160T100		160	1000	1
D180T100		G180T100		180	1000	1
D200T100		G200T100		200	1000	1
D250T100		G250T100		250	1000	1

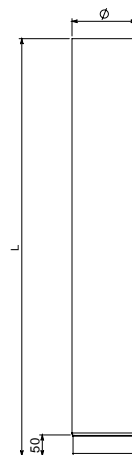

T2000

Elemento lineare

Linear element - Élément droit - Elemento lineal

Finiture disponibili - Available finishes - Finitions disponibles - Acabados disponibles

F. 01 NERO BLACK NOIR - NEGRO		F. 02 GRIGIO GREY GRIS - GRIS		Ø	L	☐
D130T2000		-		130	2000	1
D150T2000		-		150	2000	1
D180T2000		-		180	2000	1
D200T2000		-		200	2000	1

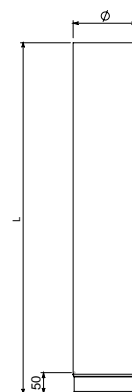

TEL5

Elemento telescopico

Telescopic element - Élément télescopique - Elemento telescópico

Finiture disponibili - Available finishes - Finitions disponibles - Acabados disponibles

F. 01 NERO BLACK NOIR - NEGRO		F. 02 GRIGIO GREY GRIS - GRIS		Ø	L	☐
D120TEL5		G120TEL5		120	500	1
D130TEL5		G130TEL5		130	500	1
D140TEL5		G140TEL5		140	500	1
D150TEL5		G150TEL5		150	500	1
D160TEL5		G160TEL5		160	500	1
D180TEL5		G180TEL5		180	500	1
D200TEL5		G200TEL5		200	500	1

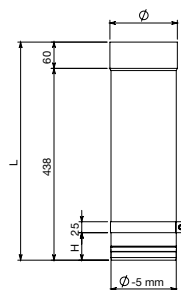

CF02

Tappo per analisi fumi M10

Cap for smoke analysis M10 - Bouchon pour analyse des fumées M10 - Tapón para análisis de humos M10

CODICE CODE - CODE CÓDIGO	
DUNVCF02	



C090

Curva a 90°

90° Bend - Coude 90° - Codo de 90°

Finiture disponibili - Available finishes - Finitions disponibles - Acabados disponibles

F. 01 NERO BLACK NOIR - NEGRO		F. 02 GRIGIO GREY GRIS - GRIS		∅	A	B	
D120C090		G120C090		120	197	270	1
D130C090		G130C090		130	202	275	1
D140C090		G140C090		140	207	280	1
D150C090		G150C090		150	212	285	1
D160C090		G160C090		160	217	280	1
D180C090		G180C090		180	227	300	1
D200C090		G200C090		200	237	315	1
D250C090		G250C090		250	267	385	1

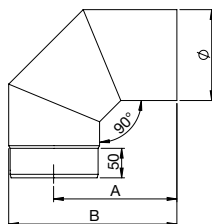

C90S

Curva a 90° con ispezione

90° Bend with inspection - Coude 90° avec trappe de visite

Codo de 90° con inspección

Finiture disponibili - Available finishes - Finitions disponibles - Acabados disponibles

F. 01 NERO BLACK NOIR - NEGRO		F. 02 GRIGIO GREY GRIS - GRIS		∅	A	B	
D120C90S		G120C90S		120	197	270	1
D130C90S		G130C90S		130	202	275	1
D140C90S		G140C90S		140	207	280	1
D150C90S		G150C90S		150	212	285	1
D160C90S		G160C90S		160	217	280	1
D180C90S		G180C90S		180	227	300	1
D200C90S		G200C90S		200	237	315	1

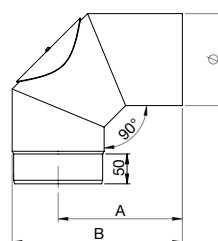

C045

Curva a 45°

45° Bend - Coude 45° - Codo de 45°

Finiture disponibili - Available finishes - Finitions disponibles - Acabados disponibles

F. 01 NERO BLACK NOIR - NEGRO		F. 02 GRIGIO GREY GRIS - GRIS		∅	A	B	L	S	
D120C045		G120C045		120	146	265	579	219	1
D130C045		G130C045		130	150	265	579	219	1
D140C045		G140C045		140	155	265	579	219	1
D150C045		G150C045		150	159	265	579	219	1
D160C045		G160C045		160	163	265	579	219	1
D180C045		G180C045		180	171	265	579	219	1
D200C045		G200C045		200	179	265	579	219	1
D250C045		G250C045		250	200	265	579	219	1

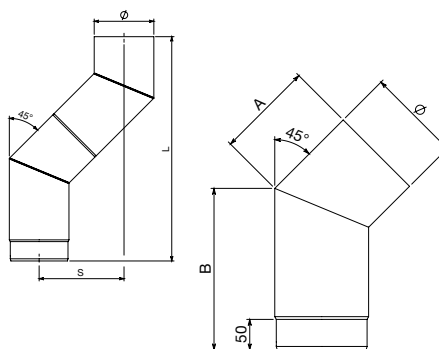

C45S

Curva a 45° con ispezione

45° Bend with inspection - Coude 45° avec trappe de visite

Codo de 45° con inspección

Finiture disponibili - Available finishes - Finitions disponibles - Acabados disponibles

F. 01 NERO BLACK NOIR - NEGRO		F. 02 GRIGIO GREY GRIS - GRIS		∅	A	B	L	S	
D120C45S		G120C45S		120	146	265	579	219	1
D130C45S		G130C45S		130	150	265	579	219	1
D140C45S		G140C45S		140	155	265	579	219	1
D150C45S		G150C45S		150	159	265	579	219	1
D160C45S		G160C45S		160	163	265	579	219	1
D180C45S		G180C45S		180	171	265	579	219	1
D200C45S		G200C45S		200	179	265	579	219	1

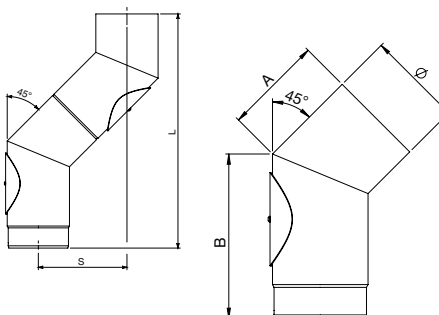

C45P

Curva a 45° corta

45° Short bend - Coude 45° court - Codo de 45° corto

Finiture disponibili - Available finishes - Finitions disponibles - Acabados disponibles

F. 01 NERO BLACK NOIR - NEGRO	F. 02 GRIGIO GREY GRIS - GRIS	Ø	A	B	L	S	
D120C45P	G120C45P	120	126	126	308	107	1
D130C45P	G130C45P	130	130	130	315	110	1
D140C45P	G140C45P	140	134	134	322	113	1
D150C45P	G150C45P	150	138	138	329	116	1
D160C45P	G160C45P	160	143	143	337	119	1
D180C45P	G180C45P	180	151	151	351	124	1
D200C45P	G200C45P	200	159	159	365	130	1

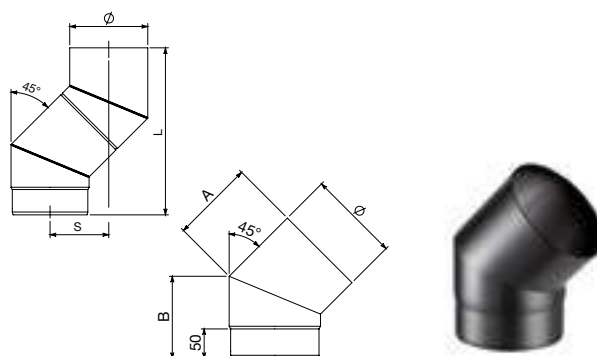

ORS

Curva orientabile a tre settori

Three sectors revolving bend - Coude orientable trois secteurs

Codo orientable de tres secciones

Finiture disponibili - Available finishes - Finitions disponibles - Acabados disponibles

F. 01 NERO BLACK NOIR - NEGRO	F. 02 GRIGIO GREY GRIS - GRIS	Ø	A	B	
D120ORS	G120ORS	120	191	270	1
D130ORS	G130ORS	130	196	275	1
D140ORS	G140ORS	140	201	280	1
D150ORS	G150ORS	150	206	285	1
D160ORS	G160ORS	160	211	290	1
D180ORS	G180ORS	180	221	300	1
D200ORS	G200ORS	200	231	310	1

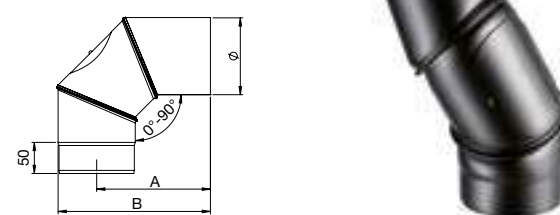

ORS4

Curva orientabile a quattro settori

Four sectors revolving bend - Coude orientable quatre secteurs

Codo orientable de cuatro secciones

Finiture disponibili - Available finishes - Finitions disponibles - Acabados disponibles

F. 01 NERO BLACK NOIR - NEGRO	F. 02 GRIGIO GREY GRIS - GRIS	Ø	A	B	
D120ORS4	-	120	215	425	1
D130ORS4	-	130	180	385	1
D140ORS4	-	140	150	420	1
D150ORS4	-	150	200	435	1
D160ORS4	-	160	180	440	1
D180ORS4	-	180	200	440	1
D200ORS4	-	200	200	440	1

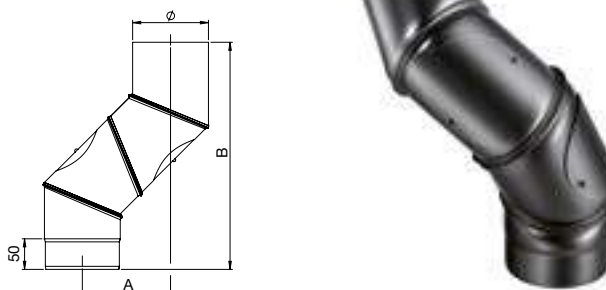

RACT

Raccordo a "T" femmina-femmina

Tee pipe fitting female-female - Té 90° femelle-femelle

Racor en "T" hembra-hembra

Finiture disponibili - Available finishes - Finitions disponibles - Acabados disponibles

F. 01 NERO BLACK NOIR - NEGRO	F. 02 GRIGIO GREY GRIS - GRIS	Ø	L	L1	
D120RACT	G120RACT	120	330	165	1
D130RACT	G130RACT	130	330	165	1
D140RACT	G140RACT	140	350	175	1
D150RACT	G150RACT	150	350	175	1
D160RACT	G160RACT	160	400	200	1
D180RACT	G180RACT	180	400	200	1
D200RACT	G200RACT	200	400	200	1

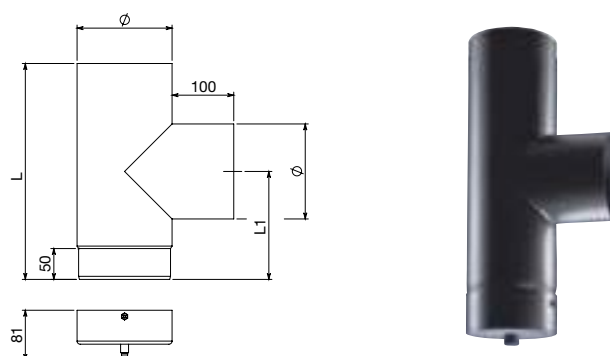

RID/AMP

Riduzione/Ampliamento

Reducer/Enlarger - Réduction/Augmentation - Reducción/Extensión

Finiture disponibili - Available finishes - Finitions disponibles - Acabados disponibles

F. 01 NERO BLACK NOIR - NEGRO	F. 02 GRIGIO GREY GRIS - GRIS	Ø1	Ø2	A	B	
RID200F180M	GRID200F180M	200F	180M	65	85	1
RID180F150M	GRID180F150M	180F	150M	65	85	1
RID160F150M	GRID160F150M	160F	150M	65	85	1
RID150F140M	GRID150F140M	150F	140M	65	85	1
RID150F130M	GRID150F130M	150F	130M	65	85	1
RID150F120M	GRID150F120M	150F	120M	65	85	1
RID140F130M	GRID140F130M	140F	130M	65	85	1
RID140F120M	GRID140F120M	140F	120M	65	85	1
RID130F120M	GRID130F120M	130F	120M	65	85	1
RID130M120F	GRID130M120F	130M	120F	65	85	1
RID140M120F	GRID140M120F	140M	120F	65	85	1
RID150M120F	GRID150M120F	150M	120F	65	85	1
RID140M130F	GRID140M130F	140M	130F	65	85	1
RID150M130F	GRID150M130F	150M	130F	65	85	1
RID150M140F	GRID150M140F	150M	140F	65	85	1
AMP12013	-	120F	138	65	85	1
AMP12014	-	120F	148	65	85	1
AMP12015	-	120F	158	65	85	1
AMP13014	-	130F	148	65	85	1
AMP13015	-	130F	158	65	85	1
AMP14015	-	140F	158	65	85	1

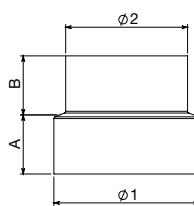

Si realizzano riduzioni speciali su richiesta. Vedi pag. 39.
Special reductions are made on request. See pag. 39.
On produit réductions spéciales sur demande. Voir page 39.
Reducciones especiales disponibles bajo pedido. Ver página 39.

MASC

Manicotto maschio/maschio

Muff male/male - Manchon mâle/mâle - Manguito macho/macho

Finiture disponibili - Available finishes - Finitions disponibles - Acabados disponibles

F. 01 NERO BLACK NOIR - NEGRO	F. 02 GRIGIO GREY GRIS - GRIS	Ø	
D120MASC	G120MASC	120	1
D130MASC	G130MASC	130	1
D140MASC	G140MASC	140	1
D150MASC	G150MASC	150	1
D160MASC	G160MASC	160	1
D180MASC	G180MASC	180	1
D200MASC	G200MASC	200	1

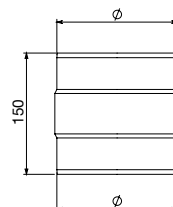

FEMM

Manicotto femmina/femmina

Muff female/female - Manchon femelle/femelle - Manguito hembra/hembra

Finiture disponibili - Available finishes - Finitions disponibles - Acabados disponibles

F. 01 NERO BLACK NOIR - NEGRO	F. 02 GRIGIO GREY GRIS - GRIS	Ø	
D120FEMM	G120FEMM	120	1
D130FEMM	G130FEMM	130	1
D140FEMM	G140FEMM	140	1
D150FEMM	G150FEMM	150	1
D160FEMM	G160FEMM	160	1
D180FEMM	G180FEMM	180	1
D200FEMM	G200FEMM	200	1

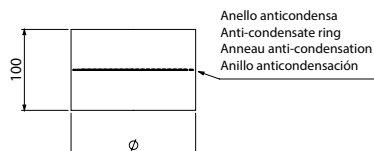

ADT1

Adattatore legna maschio / inox mono femmina

Single wall adaptor wood male / inox female - Adaptateur simple paroi bois mâle / femelle inox

Adaptador madera macho / acero inoxidable mono hembra

Finiture disponibili - Available finishes - Finitions disponibles - Acabados disponibles

F. 01 NERO BLACK NOIR - NEGRO		F. 02 GRIGIO GREY GRIS - GRIS		Ø	h	📦
D120ADT1		G120ADT1				
D130ADT1		G130ADT1		130	130	1
D140ADT1		G140ADT1		140	130	1
D150ADT1		G150ADT1		150	130	1
D160ADT1		G160ADT1		160	130	1
D180ADT1		G180ADT1		180	130	1
D200ADT1		G200ADT1		200	130	1

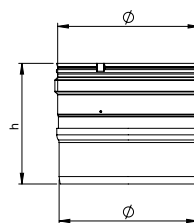

ADT2

Adattatore legna femmina / inox mono maschio

Single wall adaptor wood female / inox male - Adaptateur simple paroi bois femelle / mâle inox

Adaptador madera hembra / acero inoxidable mono macho

Finiture disponibili - Available finishes - Finitions disponibles - Acabados disponibles

F. 01 NERO BLACK NOIR - NEGRO		F. 02 GRIGIO GREY GRIS - GRIS		Ø	h	📦
D120ADT2		G120ADT2				
D130ADT2		G130ADT2		130	132	1
D140ADT2		G140ADT2		140	132	1
D150ADT2		G150ADT2		150	132	1
D160ADT2		G160ADT2		160	132	1
D180ADT2		G180ADT2		180	132	1
D200ADT2		G200ADT2		200	132	1

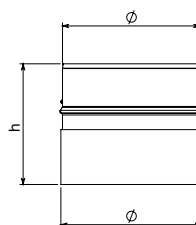

ADT3

Adattatore legna femmina / inox mono femmina

Single wall adaptor wood female / inox female - Adaptateur simple paroi bois femelle / femelle inox

Adaptador madera hembra / acero inoxidable mono hembra

Finiture disponibili - Available finishes - Finitions disponibles - Acabados disponibles

F. 01 NERO BLACK NOIR - NEGRO		F. 02 GRIGIO GREY GRIS - GRIS		Ø	h	📦
D120ADT3		G120ADT3				
D130ADT3		G130ADT3		130	130	1
D140ADT3		G140ADT3		140	130	1
D150ADT3		G150ADT3		150	130	1
D160ADT3		G160ADT3		160	130	1
D180ADT3		G180ADT3		180	130	1
D200ADT3		G200ADT3		200	130	1

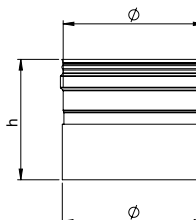

ADT4

Adattatore legna maschio / inox mono maschio

Single wall adaptor wood male / inox male - Adaptateur simple paroi bois mâle / mâle inox

Adaptador madera macho / acero inoxidable mono macho

Finiture disponibili - Available finishes - Finitions disponibles - Acabados disponibles

F. 01 NERO BLACK NOIR - NEGRO		F. 02 GRIGIO GREY GRIS - GRIS		Ø	h	📦
D120ADT4		G120ADT4				
D130ADT4		G130ADT4		130	134	1
D140ADT4		G140ADT4		140	134	1
D150ADT4		G150ADT4		150	134	1
D160ADT4		G160ADT4		160	134	1
D180ADT4		G180ADT4		180	134	1
D200ADT4		G200ADT4		200	134	1

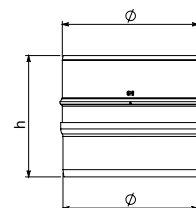

RAS

Raccordo telescopico a soffitto completo di rosone

Telescopic ceiling pipe-fitting with ring - Raccord télescopique pour plafond avec rosace
Racor telescópico de techo con embellecedor

Finiture disponibili - Available finishes - Finitions disponibles - Acabados disponibles

F. 01 NERO BLACK NOIR - NEGRO		F. 02 GRIGIO GREY GRIS - GRIS		Ø	Ø1	Ø2	h	
D12ORAS		G12ORAS		120	120F	300	222	1
D13ORAS		G13ORAS		130	130F	300	222	1
D14ORAS		G14ORAS		140	140F	300	222	1
D15ORAS		G15ORAS		150	150F	300	222	1
D16ORAS		G16ORAS		160	160F	300	222	1
D18ORAS		G18ORAS		180	180F	300	222	1
D20ORAS		G20ORAS		200	200F	400	222	1

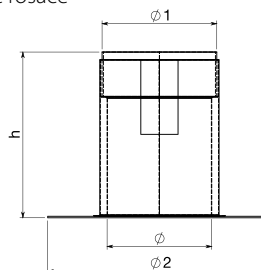

RASO

Raccordo telescopico a soffitto orientabile 0°-30°

Telescopic adjustable pipe-fitting 0°-30°
Raccord télescopique orientable pour plafond 0°-30°
Racor telescópico de techo orientable 0°-30°

Finiture disponibili - Available finishes - Finitions disponibles - Acabados disponibles

F. 01 NERO BLACK NOIR - NEGRO		F. 02 GRIGIO GREY GRIS - GRIS		Ø	Ø1	Ø2	h	h1	h2	
D12ORASO		G12ORASO		120	120F	300	300	100	200	1
D13ORASO		G13ORASO		130	130F	300	300	100	200	1
D14ORASO		G14ORASO		140	140F	300	300	100	200	1
D15ORASO		G15ORASO		150	150F	300	300	100	200	1
D16ORASO		G16ORASO		160	160F	400	300	100	200	1
D18ORASO		G18ORASO		180	180F	400	300	100	200	1
D20ORASO		G20ORASO		200	200F	400	300	100	200	1

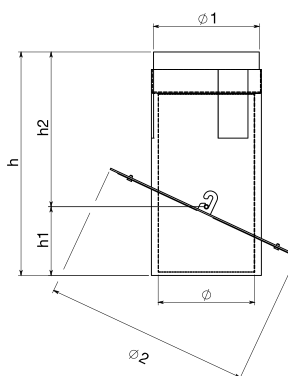

Articolo fornito completo di viteria - Article supplied complete with screws - Article livré complet avec vis - Artículo suministrado completo con tornillos

RAM

Raccordo telescopico a muro

Telescopic wall pipe-fitting - Raccord télescopique mural
Racor telescópico de pared

Finiture disponibili - Available finishes - Finitions disponibles - Acabados disponibles

F. 01 NERO BLACK NOIR - NEGRO		F. 02 GRIGIO GREY GRIS - GRIS		Ø	Ø1	h	
D12ORAM		-		120	120F	176	1
D13ORAM		-		130	130F	176	1
D14ORAM		-		140	140F	176	1
D15ORAM		-		150	150F	176	1
D16ORAM		-		160	160F	176	1
D18ORAM		-		180	180F	176	1
D20ORAM		-		200	200F	176	1

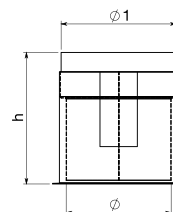

RACC

Raccordo a parete con rosone

Wall pipe-fitting with ring - Raccord mural avec rosace
Racor de pared con embellecedor

Finiture disponibili - Available finishes - Finitions disponibles - Acabados disponibles

F. 01 NERO BLACK NOIR - NEGRO		F. 02 GRIGIO GREY GRIS - GRIS		Ø	Ø1	h	
RACC120P		GRAC120P		120	250	150	1
RACC130P		GRAC130P		130	250	150	1
RACC140P		GRAC140P		140	250	150	1
RACC150P		GRAC150P		150	250	150	1
RACC160P		GRAC160P		160	250	150	1
RACC180P		GRAC180P		180	250	150	1
RACC200P		GRAC200P		200	325	150	1

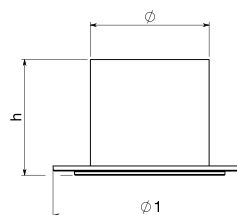

ROSE

Rosone

Ring - Rosace - Embellecedor

Finiture disponibili - Available finishes - Finitions disponibles - Acabados disponibles

F. 01 NERO BLACK NOIR - NEGRO		F. 02 GRIGIO GREY GRIS - GRIS		Ø	Ø1	Ø2	
D120ROSE		G120ROSE		120	250	125	1
D130ROSE		G130ROSE		130	250	135	1
D140ROSE		G140ROSE		140	250	145	1
D150ROSE		G150ROSE		150	250	155	1
D160ROSE		G160ROSE		160	250	165	1
D180ROSE		G180ROSE		180	250	185	1

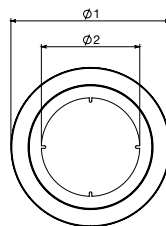

ROS3

Rosone a tre fori

Ring with three holes - Rosace avec trois trous

Embellecedor de tres orificios

Finiture disponibili - Available finishes - Finitions disponibles - Acabados disponibles

F. 01 NERO BLACK NOIR - NEGRO		F. 02 GRIGIO GREY GRIS - GRIS		Ø	Ø1	Ø2	
D120ROS3		G120ROS3		120	250	126	1
D130ROS3		G130ROS3		130	250	136	1
D140ROS3		G140ROS3		140	300	146	1
D150ROS3		G150ROS3		150	300	156	1
D160ROS3		G160ROS3		160	300	166	1
D180ROS3		G180ROS3		180	300	186	1
D200ROS3		G200ROS3		200	325	206	1
D250ROS3		G250ROS3		250	400	256	1

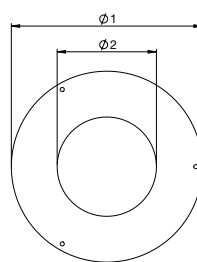

Articolo fornito completo di viteria - Article supplied complete with screws - Article livré complet avec vis - Artículo suministrado completo con tornillos

FINZ

Piastra tonda di finitura

Round finishing plate - Plaque ronde de finition - Placa redonda de acabado

Finiture disponibili - Available finishes - Finitions disponibles - Acabados disponibles

F. 01 NERO BLACK NOIR - NEGRO		F. 02 GRIGIO GREY GRIS - GRIS		Ø1	Ø2	
D120FINZ		G120FINZ		230	126	1
D130FINZ		G130FINZ		240	136	1
D140FINZ		G140FINZ		250	146	1
D150FINZ		G150FINZ		260	156	1
D160FINZ		G160FINZ		270	166	1
D180FINZ		G180FINZ		290	186	1
D200FINZ		G200FINZ		310	206	1
D250FINZ		G250FINZ		360	256	1

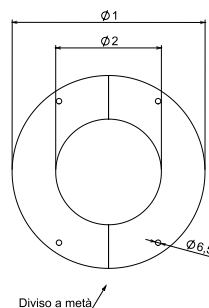

Articolo fornito completo di viteria - Article supplied complete with screws - Article livré complet avec vis - Artículo suministrado completo con tornillos

ROEL

Rosone ellittico

Elliptical ring - Rosace elliptique - Embellecedor elíptico

Finiture disponibili - Available finishes - Finitions disponibles - Acabados disponibles

F. 01 NERO BLACK NOIR - NEGRO		F. 02 GRIGIO GREY GRIS - GRIS		Ø	Ø1	Ø2	
D120ROEL		-		120	300	128	1
D130ROEL		-		130	300	138	1
D140ROEL		-		140	300	148	1
D150ROEL		-		150	300	158	1
D160ROEL		-		160	400	168	1
D180ROEL		-		180	400	188	1
D200ROEL		-		200	400	208	1

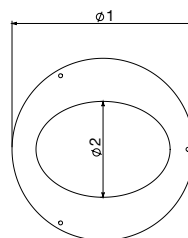

Articolo fornito completo di viteria - Article supplied complete with screws - Article livré complet avec vis - Artículo suministrado completo con tornillos

FASC

Fascetta reggitubo

Support pipe clip - Collier de soutien pour tuyau - Abrazadera para tubo

Finiture disponibili - Available finishes - Finitions disponibles - Acabados disponibles

F. 01 NERO BLACK NOIR - NEGRO		F. 02 GRIGIO GREY GRIS - GRIS		Ø	📦
FASCD120		FASCG120		120	1
FASCD130		FASCG130		130	1
FASCD140		FASCG140		140	1
FASCD150		FASCG150		150	1
FASCD160		FASCG160		160	1
FASCD180		FASCG180		180	1
FASCD200		FASCG200		200	1

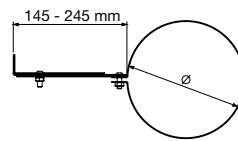

Articolo fornito completo di viteria - Article supplied complete with screws - Article livré complet avec vis - Artículo suministrado completo con tornillos

VALV

Valvola a farfalla intercambiabile

Damper valve - Papillon clé - Válvula de mariposa intercambiabile

Finiture disponibili - Available finishes - Finitions disponibles - Acabados disponibles

F. 01 NERO BLACK NOIR - NEGRO		F. 02 GRIGIO GREY GRIS - GRIS		Ø	📦
D120VALV		G120VALV		120	1
D130VALV		G130VALV		130	1
D140VALV		G140VALV		140	1
D150VALV		G150VALV		150	1
D160VALV		G160VALV		160	1
D180VALV		G180VALV		180	1
D200VALV		G200VALV		200	1

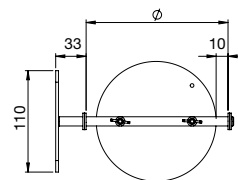

DCISP

Guarnizione per ispezione curva

Gasket for inspection door - Joint pour trappe de visite

Junta para inspección curva

CODICE CODE - CODE CÓDIGO	Ø	📦
DCISPPXX	dal 120 al 140	1
DCISPGXX	dal 150 al 250 e per tutte le ORS e ORS4 from 150 to 250 and for all ORS and ORS4 de 150 à 250 et pour tous les ORS et ORS4 del 150 al 250 y para todos los ORS y ORS4	1

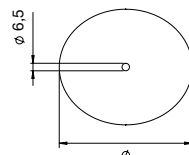

PEDANA1

Piano salvapavimento

Floor-protection board - Plaque de protection sol

Protector de suelo

Finiture disponibili - Available finishes - Finitions disponibles - Acabados disponibles

F. 01 NERO BLACK NOIR - NEGRO		F. 02 GRIGIO GREY GRIS - GRIS		A	B	📦
PEDANA1		PEDANA1G		1000	900	1

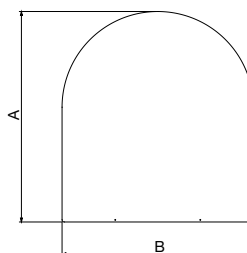

Realizziamo pedane su misura a richiesta.
We manufacture custom floor boards upon request.
Nous produisons des plaques sur mesure à la demande.
Fabricamos protectores de suelo a medida bajo pedido.

PEDANA2

Piano salvapavimento

Floor-protection board - Plaque de protection sol
Protector de suelo

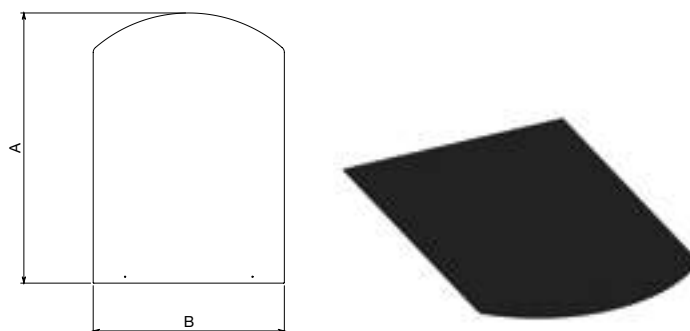

Finiture disponibili - Available finishes - Finitions disponibles - Acabados disponibles

F. 01 NERO BLACK NOIR - NEGRO PEDANA2		F. 02 GRIGIO GREY GRIS - GRIS PEDANA2G		A	B	
				800	600	1

Realizziamo pedane su misura a richiesta.
We manufacture custom floor boards upon request.
Nous produisons des plaques sur mesure à la demande.
Fabricamos protectores de suelo a medida bajo pedido.

RID

Riduzione speciale

Special reduction - Réduction sur mesure - Reducción especial

Su richiesta - Upon request - Sur demande - Bajo pedido

Componi così il tuo codice

Compose your code in this way

Composez votre code de cette façon

Así es como compones tu código

RID colore nero/GRID colore grigio
RID black color/GRID grey color
RID couleur noir/GRID couleur gris
RID color negro/GRID Color gris

Ø1

M=maschio/F=femmina

M=male/F=female

M=mâle/F=femelle

M=macho/F=hembra

RID 180 F 150 F

Ø2

M=maschio/F=femmina

M=male/F=female

M=mâle/F=femelle

M=macho/F=hembra



FEMM/FEMM

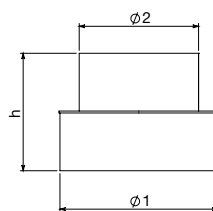

FEMM/MASC

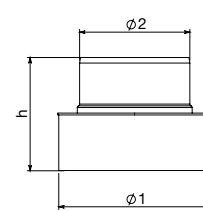

MASC/FEMM

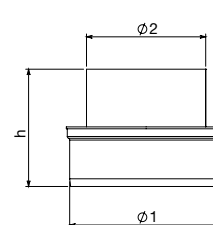

MASC/MASC

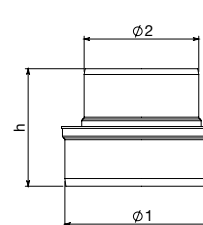

Finiture disponibili - Available finishes - Finitions disponibles - Acabados disponibles

F. 01 NERO BLACK NOIR - NEGRO		F. 02 GRIGIO GREY GRIS - GRIS		DIAMETRI DIAMETERS / DIAMETRES / DIÁMETROS			h	
codice		codice		fino al diam 180 / up to diam 180 / jusqu' à diam 180 / hasta diámetro 180	122	1		
code - code - código		code - code - código		fino al diam 200 / up to diam 200 / jusqu' à diam 200 / hasta diámetro 200	122	1		
				fino al diam 250 / up to diam 250 / jusqu' à diam 250 / hasta diámetro 250	122	1		

Per formulare il prezzo considerare il diametro Ø1 - To calculate the price, consider Ø1 - Pour formuler le prix, considérer Ø1 - Para formular el precio considerar el diámetro Ø1